

# ***FILTER-BOX WITH PANEL FILTERS FOR ROUND AIR DUCTS***



*Clean Box 100*

*Clean Box 125*

*Clean Box 150*

*Clean Box 200*

**EN**

**USER'S MANUAL**



**BLAUBERG**  
*Ventilatoren*

## CONTENTS

Safety requirements.....	2
Purpose.....	4
Delivery set.....	4
Designation key.....	4
Technical data.....	5
Design and operating principle .....	7
Installation and set-up.....	7
Connection to power mains .....	8
Technical maintenance.....	9
Storage and transportation regulations.....	9
Manufacturer's warranty.....	10
Certificate of acceptance.....	11
Seller information.....	11
Installation certificate.....	11
Warranty card.....	11

This user's manual is a main operating document intended for technical, maintenance, and operating staff.

The manual contains information about the purpose, technical details, operating principle, design, and installation of the Clean Box unit (-s) and all of its (their) modifications.

Technical and maintenance staff must have theoretical and practical training in the field of ventilation systems and should be able to work in accordance with workplace safety rules as well as construction norms and standards applicable in the territory of the country.

The information in this user's manual is correct at the time of the document's preparation.

The Company reserves the right to modify the technical characteristics, design, or configuration of its products at any time in order to incorporate the latest technological developments.

No part of this publication may be reproduced, stored in a retrieval system, or transmitted, in any form or by any means in any information search system or translated into any language in any form without the prior written permission of the Company.

## SAFETY REQUIREMENTS

- Please read the user's manual carefully prior to installing and operating the unit.
- All user's manual requirements as well as the provisions of all the applicable local and national construction, electrical, and technical norms and standards must be observed when installing and operating the unit.
- The warnings contained in the user's manual must be considered most seriously since they contain vital personal safety information.
- Failure to follow the rules and safety precautions noted in this user's manual may result in an injury or unit damage.
- After a careful reading of the manual, keep it for the entire service life of the unit.
- While transferring the unit control, the user's manual must be turned over to the receiving operator.

### UNIT INSTALLATION AND OPERATION SAFETY PRECAUTIONS



- Disconnect the unit from power mains prior to any installation operations.



- Unpack the unit with care.



- The unit must be grounded!



- While installing the unit, follow the safety regulations specific to the use of electric tools.



- Do not change the power cable length at your own discretion. Do not bend the power cable. Avoid damaging the power cable. Do not put any foreign objects on the power cable.

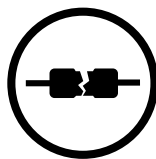

- Do not use damaged equipment or cables when connecting the unit to power mains.



- Do not touch the unit controls with wet hands. Do not carry out the installation and maintenance operations with wet hands.



- Do not allow children to operate the unit.



- Do not store any explosive or highly flammable substances in close proximity to the unit.

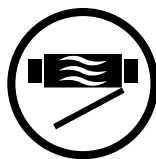

- Do not open the unit during operation.



- Do not block the air duct when the unit is switched on.

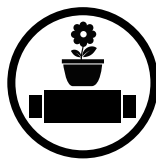

- Do not sit on the unit and avoid placing foreign objects on it.



- Do not lay the power cable of the unit in close proximity to heating equipment.

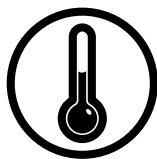

- Do not operate the unit outside the temperature range stated in the user's manual. Do not operate the unit in aggressive or explosive environments.



- Do not wash the unit with water. Protect the electric parts of the unit against ingress of water.



- Disconnect the unit from power mains prior to any technical maintenance.



- When the unit generates unusual sounds, odour, or emits smoke, disconnect it from power supply and contact the Seller.



- Do not direct the air flow produced by the unit towards open flame or ignition sources.



- In case of continuous operation of the unit, periodically check the security of mounting.



- Use the unit only for its intended purpose.



**THE PRODUCT MUST BE DISPOSED SEPARATELY AT THE END OF ITS SERVICE LIFE.  
DO NOT DISPOSE THE UNIT AS UNSORTED DOMESTIC WASTE.**

## PURPOSE

The unit is a device for purification of air circulating in ventilation systems.

The unit is a component part and is not designed for stand-alone operation.

The unit is intended for use in supply and recirculation ventilation systems for the purification of air in private homes, offices, hotels, cafés, conference halls and other utility and public spaces.



**THE UNIT SHOULD NOT BE OPERATED BY CHILDREN OR PERSONS WITH REDUCED PHYSICAL, MENTAL, OR SENSORY CAPACITIES, OR THOSE WITHOUT THE APPROPRIATE TRAINING.**

**THE UNIT MUST BE INSTALLED AND CONNECTED ONLY BY PROPERLY QUALIFIED PERSONNEL AFTER THE APPROPRIATE BRIEFING.**

**THE CHOICE OF UNIT INSTALLATION LOCATION MUST PREVENT UNAUTHORIZED ACCESS BY UNATTENDED CHILDREN.**

The unit is intended for suspended mounting.

Transported air must not contain any flammable or explosive mixtures, evaporation of chemicals, sticky substances, fibrous materials, coarse dust, soot and oil particles or environments favourable for the formation of hazardous substances (toxic substances, dust, pathogenic germs).

## DELIVERY SET

Name	Number
Filter-box	1 pc.
User's manual	1 pc.
Packing box	1 pc.

## DESIGNATION KEY

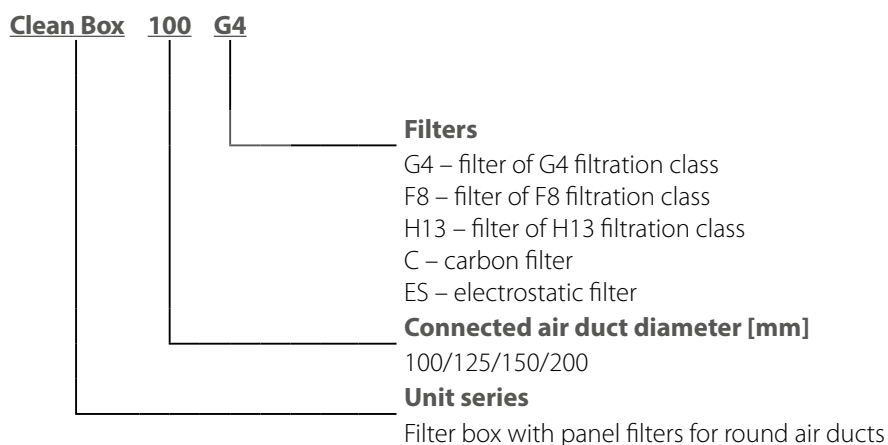

## TECHNICAL DATA

The unit is designed for operation in an enclosed area at ambient temperatures from -25 °C to +55 °C at relative humidity of up to 80 % (at +25 °C).

Ingress protection rating against access to hazardous parts and water ingress is IPX4.

The unit casing is made of painted steel.

The unit design is constantly being improved, thus some models may be slightly different from those described in this manual.

Air flow of the filter box is shown in the table below.

Name	Rated air flow [m <sup>3</sup> /h]
Cleanbox 100	250
Cleanbox 125	300
Cleanbox 150	350
Cleanbox 200	550

### Technical data

Name	Filter type	Filter size (HxWxT) [mm]			
		G4	F8	H13	Carbon
Clean Box 100 G4-F8	G4+F8	220x400x47	220x400x47	-	-
Clean Box 100 G4-F8-C	G4+F8+Carbon	220x400x47	220x400x47	-	220x400x47
Clean Box 100 G4-H13	G4+H13	220x400x47	-	220x400x47	-
Clean Box 100 G4-H13-C	G4+H13+Carbon	220x400x47	-	220x400x47	220x400x47
Clean Box 100 ES	G4+ES	220x400x47	-	-	-
Clean Box 125 G4-F8	G4+F8	220x400x47	220x400x47	-	-
Clean Box 125 G4-F8-C	G4+F8+Carbon	220x400x47	220x400x47	-	220x400x47
Clean Box 125 G4-H13	G4+H13	220x400x47	-	220x400x47	-
Clean Box 125 G4-H13-C	G4+H13+Carbon	220x400x47	-	220x400x47	220x400x47
Clean Box 125 ES	G4+ES	220x400x47	-	-	-
Clean Box 150 G4-F8	G4+F8	270x425x47	270x425x47	-	-
Clean Box 150 G4-F8-C	G4+F8+Carbon	270x425x47	270x425x47	-	270x425x47
Clean Box 150 G4-H13	G4+H13	270x425x47	-	270x425x47	-
Clean Box 150 G4-H13-C	G4+H13+Carbon	270x425x47	-	270x425x47	270x425x47
Clean Box 150 ES	G4+ES	270x425x47	-	-	-
Clean Box 200 G4-F8	G4+F8	270x590x47	270x590x47	-	-
Cleanbox 200 G4-F8-C	G4+F8+Carbon	270x590x47	270x590x47	-	270x590x47
Clean Box 200 G4-H13	G4+H13	270x590x47	-	270x590x47	-
Clean Box 200 G4-H13-C	G4+H13+Carbon	270x590x47	-	270x590x47	270x590x47
Clean Box 200 ES	G4+ES	270x590x47	-	-	-

Overall dimensions of the unit [mm]

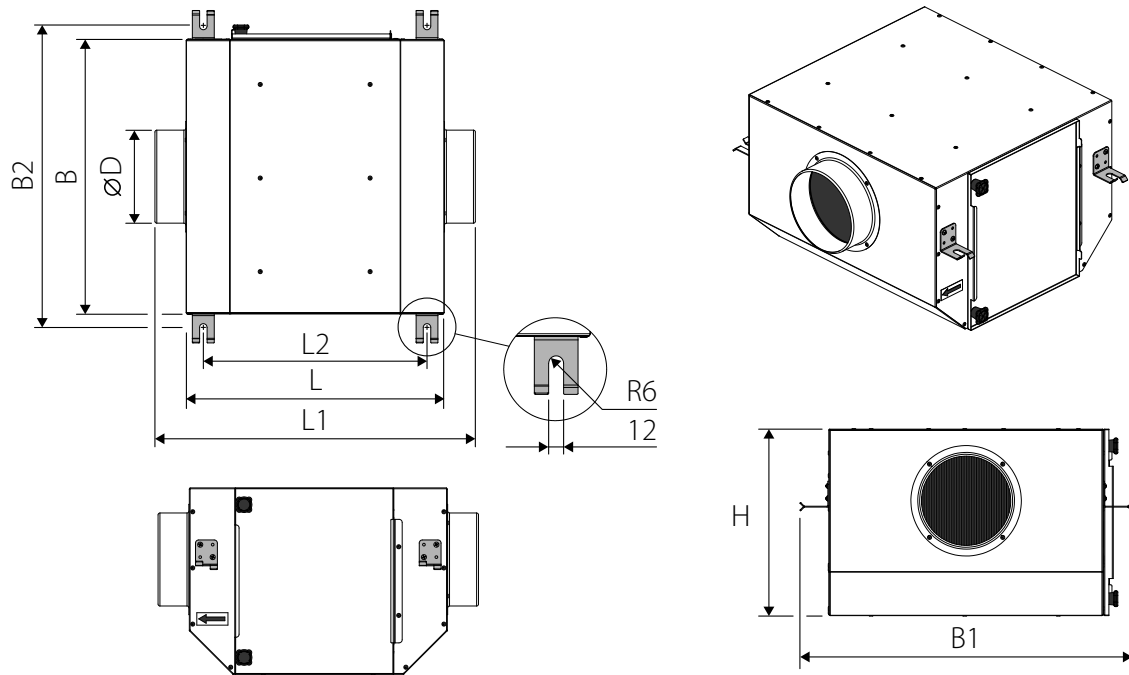

Model	D	L	H	B	L1	B1	L2	B2
Clean Box 100 G4-F8	100	413.5	249	415	513.5	508	358.5	458
Clean Box 100 G4-F8-C	100	413.5	249	415	513.5	508	358.5	458
Clean Box 100 G4-H13	100	413.5	249	415	513.5	508	358.5	458
Clean Box 100 G4-H13-C	100	413.5	249	415	513.5	508	358.5	458
Clean Box 100 ES	100	513.5	250	458	613.5	551	456	502
Clean Box 125 G4-F8	125	413.5	249	415	513.5	508	358.5	458
Clean Box 125 G4-F8-C	125	413.5	249	415	513.5	508	358.5	458
Clean Box 125 G4-H13	125	413.5	249	415	513.5	508	358.5	458
Clean Box 125 G4-H13-C	125	413.5	249	415	513.5	508	358.5	458
Clean Box 125 ES	125	513.5	250	458	613.5	551	456	502
Clean Box 150 G4-F8	150	413.5	299	440	513.5	533	358.5	483
Clean Box 150 G4-F8-C	150	413.5	299	440	513.5	533	358.5	483
Clean Box 150 G4-H13	150	413.5	299	440	513.5	533	358.5	483
Clean Box 150 G4-H13-C	150	413.5	299	440	513.5	533	358.5	483
Clean Box 150 ES	150	513.5	300	458	613.5	551	456	502
Clean Box 200 G4-F8	200	413.5	299	605	513.5	698	358.5	648
Clean Box 200 G4-F8-C	200	413.5	299	605	513.5	698	358.5	648
Clean Box 200 G4-H13	200	413.5	299	605	513.5	698	358.5	648
Clean Box 200 G4-H18-C	200	413.5	299	605	513.5	698	358.5	648
Clean Box 200 ES	200	513.5	300	658	613.5	751	456	702

**DESIGN AND OPERATING PRINCIPLE**

The unit is a box with filters of different filter class installed in it. Each unit involves installation of up to three filters with different supply air filter classes (from coarse to more fine cleaning). The air flow direction is indicated by the arrow on the fan casing.

Clean Box ... G4-F8(H13)-C

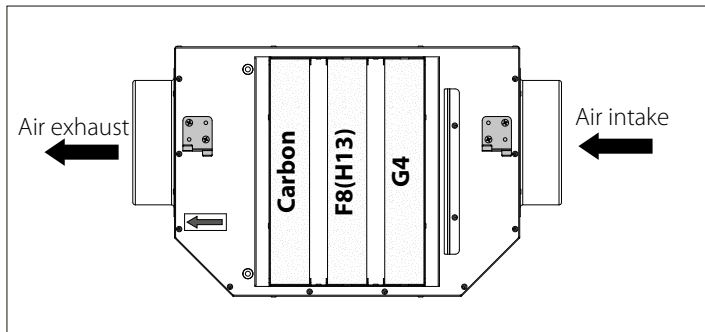

Clean Box ... ES

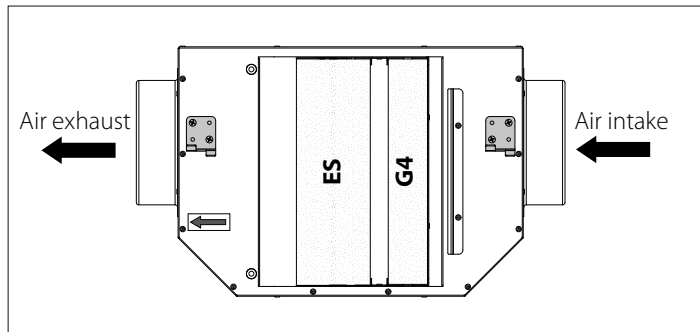

**INSTALLATION AND SET-UP**

The unit is suspended to the mounting surface through the threaded rod fixed inside the expansion anchor. While installing the unit, ensure convenient access for subsequent maintenance and repair. Fasteners for ceiling mounting are not included into delivery set and should be ordered separately. While choosing fasteners, consider the material of the mounting surface as well as the weigh of the unit, refer to the Technical data section. Fasteners for unit mounting should be selected by the service technician.

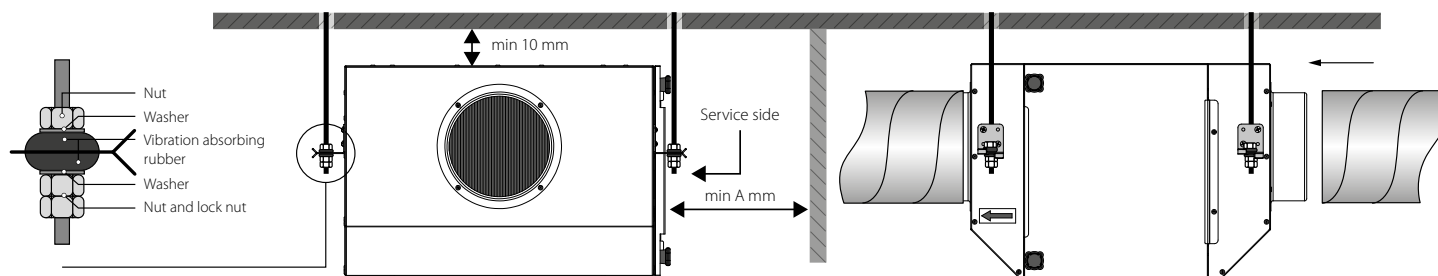

To get the best performance of the ventilation system and to minimize turbulence-induced air pressure losses, connect the straight air duct section to the spigots on both sides of the unit while installing.  
 Minimum straight air duct length:  
 equal to 1 air duct diameter on intake side  
 equal to 3 air duct diameters on outlet side



**READ THE USER'S MANUAL BEFORE INSTALLING THE UNIT.**

**CONNECTION TO POWER MAINS**

**POWER OFF THE POWER SUPPLY PRIOR TO ANY OPERATIONS WITH THE UNIT.  
THE UNIT MUST BE CONNECTED TO POWER SUPPLY BY A QUALIFIED ELECTRICIAN.  
THE RATED ELECTRICAL PARAMETERS OF THE UNIT ARE GIVEN ON THE  
MANUFACTURER'S LABEL.**



**ANY TAMPERING WITH THE INTERNAL CONNECTIONS IS PROHIBITED  
AND WILL VOID THE WARRANTY.**

The unit is rated for connection to single-phase AC 230 V/50 Hz power mains.

The connection must be made using durable, insulated and heat-resistant conductors (cables, wires).

The unit connections shall be made on the terminal block mounted inside the terminal box in strict accordance with the wiring diagram and terminal designations.

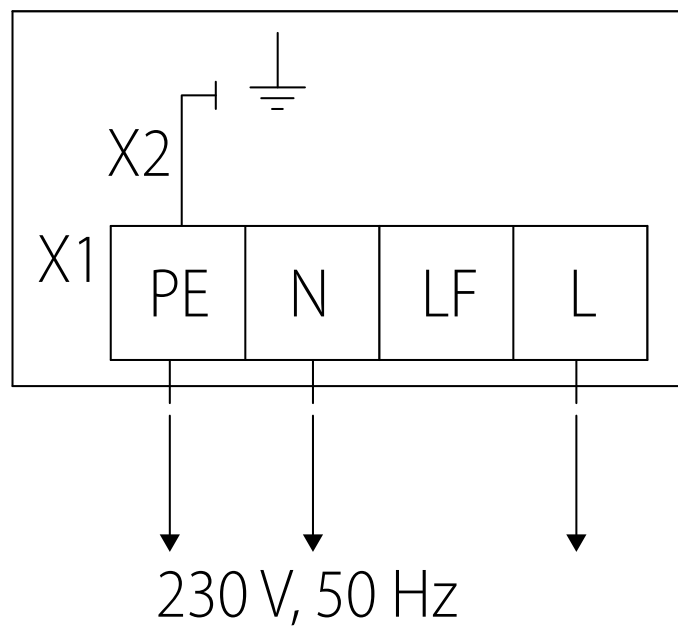
**WIRING DIAGRAM**



## TECHNICAL MAINTENANCE



**DISCONNECT THE UNIT FROM POWER SUPPLY BEFORE ANY MAINTENANCE OPERATIONS!**

Maintenance operations of the unit are required 3-4 times per year. Technical maintenance includes regular cleaning of the unit and periodic cleaning of filters. Dirty filters increase air resistance. The filters require cleaning not less than 3-4 times per year. Vacuum cleaning is allowed. After two consecutive cleanings filters must be replaced.

For new filters contact the Seller.

Filter replacement sequence:

1. Unscrew the two screws with the plastic head holding the service panel.
2. Open the service panel.
3. Pull the filters to remove.
4. Re-assemble the unit in the reverse order.

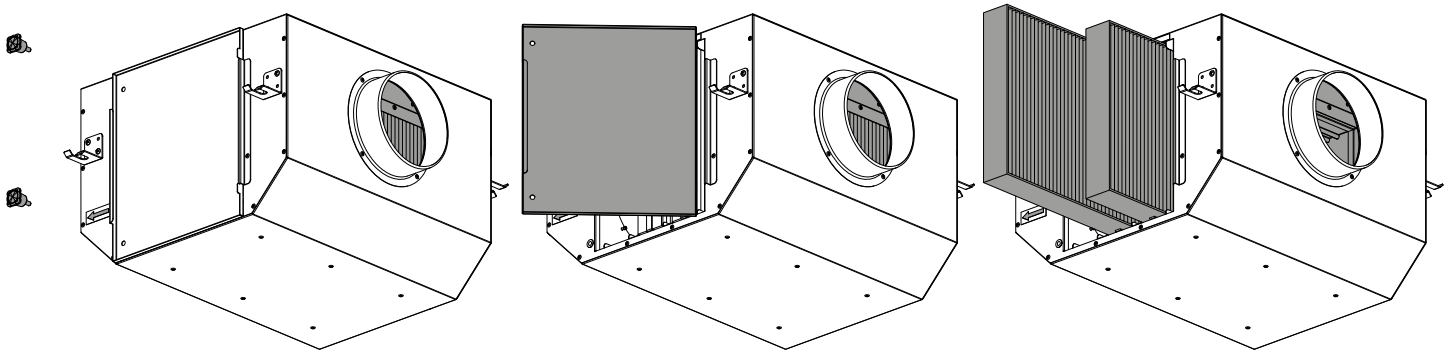

The technical maintenance of the electrostatic filter includes periodic cleaning of the surfaces from accumulated dust and dirt. Clean the electrostatic filter with a soft brush or a vacuum cleaner. Clean the filter with care. Avoid water ingress to electrical components.

## STORAGE AND TRANSPORTATION REGULATIONS

- Store the unit in the manufacturer's original packaging box in a dry closed ventilated premise with temperature range from +5 °C to + 40 °C and relative humidity up to 70 %.
- Storage environment must not contain aggressive vapors and chemical mixtures provoking corrosion, insulation, and sealing deformation.
- Use suitable hoist machinery for handling and storage operations to prevent possible damage to the unit.
- Follow the handling requirements applicable for the particular type of cargo.
- The unit can be carried in the original packaging by any mode of transport provided proper protection against precipitation and mechanical damage. The unit must be transported only in the working position.
- Avoid sharp blows, scratches, or rough handling during loading and unloading.
- Prior to the initial power-up after transportation at low temperatures, allow the unit to warm up at operating temperature for at least 3-4 hours.

## MANUFACTURER'S WARRANTY

The product is in compliance with EU norms and standards on low voltage guidelines and electromagnetic compatibility. We hereby declare that the product complies with the provisions of Electromagnetic Council Directive 2014/30/EU, Low Voltage Directive 2014/35/EU and CE-marking Directive 93/68/EEC. This certificate is issued following test carried out on samples of the product referred to above. The manufacturer hereby warrants normal operation of the unit for 24 months after the retail sale date provided the user's observance of the transportation, storage, installation, and operation regulations. Should any malfunctions occur in the course of the unit operation through the Manufacturer's fault during the guaranteed period of operation, the user is entitled to get all the faults eliminated by the manufacturer by means of warranty repair at the factory free of charge. The warranty repair includes work specific to elimination of faults in the unit operation to ensure its intended use by the user within the guaranteed period of operation. The faults are eliminated by means of replacement or repair of the unit components or a specific part of such unit component.

### The warranty repair does not include:

- routine technical maintenance
- unit installation/dismantling
- unit setup

To benefit from warranty repair, the user must provide the unit, the user's manual with the purchase date stamp, and the payment paperwork certifying the purchase. The unit model must comply with the one stated in the user's manual. Contact the Seller for warranty service.

### The manufacturer's warranty does not apply to the following cases:

- User's failure to submit the unit with the entire delivery package as stated in the user's manual including submission with missing component parts previously dismantled by the user.
- Mismatch of the unit model and the brand name with the information stated on the unit packaging and in the user's manual.
- User's failure to ensure timely technical maintenance of the unit.
- External damage to the unit casing (excluding external modifications as required for installation) and internal components caused by the user.
- Redesign or engineering changes to the unit.
- Replacement and use of any assemblies, parts and components not approved by the manufacturer.
- Unit misuse.
- Violation of the unit installation regulations by the user.
- Violation of the unit control regulations by the user.
- Unit connection to power mains with a voltage different from the one stated in the user's manual.
- Unit breakdown due to voltage surges in power mains.
- Discretionary repair of the unit by the user.
- Unit repair by any persons without the manufacturer's authorization.
- Expiration of the unit warranty period.
- Violation of the unit transportation regulations by the user.
- Violation of the unit storage regulations by the user.
- Wrongful actions against the unit committed by third parties.
- Unit breakdown due to circumstances of insuperable force (fire, flood, earthquake, war, hostilities of any kind, blockades).
- Missing seals if provided by the user's manual.
- Failure to submit the user's manual with the unit purchase date stamp.
- Missing payment paperwork certifying the unit purchase.



**FOLLOWING THE REGULATIONS STIPULATED HEREIN WILL ENSURE A LONG AND TROUBLE-FREE OPERATION OF THE UNIT.**



**USER'S WARRANTY CLAIMS SHALL BE SUBJECT TO REVIEW ONLY UPON PRESENTATION OF THE UNIT, THE PAYMENT DOCUMENT AND THE USER'S MANUAL WITH THE PURCHASE DATE STAMP.**

**CERTIFICATE OF ACCEPTANCE**

<b>Unit Type</b>	Filter box with panel filters for round air ducts
<b>Model</b>	Clean Box _____
<b>Serial Number</b>	
<b>Manufacture Date</b>	
<b>Quality Inspector's Stamp</b>	

**SELLER INFORMATION**

<b>Seller</b>	
<b>Address</b>	
<b>Phone Number</b>	
<b>E-mail</b>	
<b>Purchase Date</b>	
This is to certify acceptance of the complete unit delivery with the user's manual. The warranty terms are acknowledged and accepted.	
<b>Customer's Signature</b>	

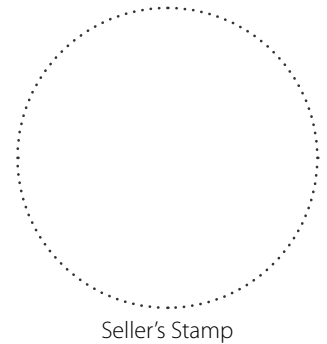

**INSTALLATION CERTIFICATE**

The Clean Box _____ unit is installed pursuant to the requirements stated in the present user's manual.	
<b>Seller</b>	
<b>Address</b>	
<b>Phone Number</b>	
<b>Installation Technician's Full Name</b>	
<b>Installation Date:</b>	<b>Signature:</b>
The unit has been installed in accordance with the provisions of all the applicable local and national construction, electrical and technical codes and standards. The unit operates normally as intended by the manufacturer.	
<b>Signature:</b>	

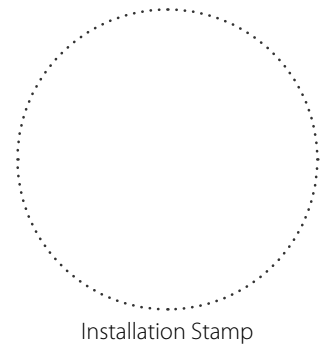

**WARRANTY CARD**

<b>Unit Type</b>	Filter box with panel filters for round air ducts
<b>Model</b>	Clean Box _____
<b>Serial Number</b>	
<b>Manufacture Date</b>	
<b>Purchase Date</b>	
<b>Warranty Period</b>	
<b>Seller</b>	

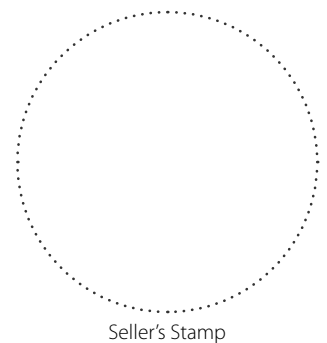



**BLAUBERG**  
*Ventilatoren*



[www.blaubergventilatoren.de](http://www.blaubergventilatoren.de)

B185EN-05