

BOX-S

Duct smoke extraction fan

Use

- The dual-purpose fan is used in emergency exhaust ventilation systems for forced removal of smoke, heated gases and combustion products, as well as for general exhaust ventilation of shopping centres, garages, warehouses, kitchens.



Air flow:
up to 28 500 m³/h



Transported air temperature:
400 °C/2 hours

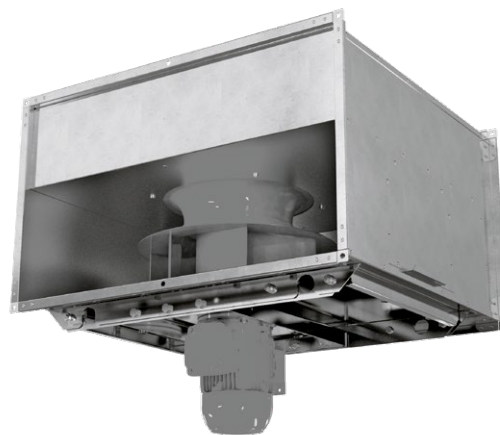

Operation

- The fan is designed to remove smoke and air mixtures up to +400 °C for 120 minutes and for continuous operation at a temperature of the transported medium up to +100 °C.
- The fans can be equipped with a frequency converter for controlling the rotation frequency.

Design

- The fan casing is made of galvanized steel.
- The impeller with backward curved blades made of heat-resisting steel.

Motor

- The fans can be equipped with a single- or three-phase electric motor with power from 0.37 to 7.5 kW, degree of protection IP54 and designed for connection to 230/400 V, 50(60) Hz power mains.
- Single-speed fans are equipped with 2 or 4 pole motors.
- Two-speed fans are equipped with 2/4, 4/6, 4/8 pole motors.
- The electric motor is installed outside the air flow.

Overall dimensions [mm]

Model	A	A1	A2	B	B1	B2	C	D	Weight [kg]
BOX-S 25	500	520	540	300	320	340	680	557	40
BOX-S 28	600	620	640	300	320	340	680	558	40
BOX-S 31	600	620	640	350	370	390	680	624	56
BOX-S 35	700	720	740	400	420	440	680	657	51
BOX-S 40	700	720	740	500	520	540	680	772	70
BOX-S 40...60Hz	700	720	740	500	520	540	680	816	66
BOX-S 45	800	820	840	600	620	640	800	872	89
BOX-S 45...60Hz	800	820	840	600	620	640	800	918	83
BOX-S 50	800	820	840	600	620	640	840	914	97
BOX-S 50...60Hz	800	820	840	600	620	640	840	954	95
BOX-S 56	900	920	940	700	720	740	840	1058	100
BOX-S 56...60Hz	900	920	940	700	720	740	840	1103	118
BOX-S 63	1000	1020	1040	800	820	840	1040	1150	130
BOX-S 71	1200	1220	1245	900	920	945	1040	1354	178

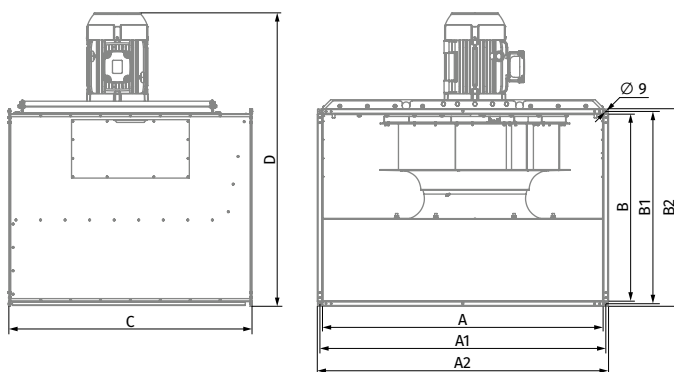

Designation key

Model	Impeller standard size [cm]	Pole number	Number of phases	Motor power [kW]	Spigot dimension [cm]	Frequency, Hz
BOX-S: rectangular duct fan for smoke removal	25; 28; 31; 35; 40; 45; 50; 56; 63; 71	2: single-speed fan 4: single-speed fan 6: single-speed fan 2/4: two-speed fan 4/6: two-speed fan	E: single-phase D: three-phase	x: single-speed x/x: two-speed	50x30; 60x30; 60x35; 70x40; 70x50; 80x60; 90x70; 100x80; 120x90	_: 50 Hz 60Hz: 60 Hz

Technical data

Standard size	Number of poles	Voltage [V/50 Hz]	Fan model	Rated power Ny [kW]	RPM [min ⁻¹]	High speed chart number	Low speed chart number
250	2	1~230	BOX-S 25-2E/0.37-50x30	0.37	2880	①	-
	2	3~400	BOX-S 25-2D/0.37-50x30	0.37	2880	①	-
	2/4	3~400	BOX-S 25-2/4D/0.37/0.1-50x30	0.37/0.1	2880/1440	①	②
280	2	1~230	BOX-S 28-2E/0.55-60x30	0.55	2880	③	-
	2	3~400	BOX-S 28-2D/0.55-60x30	0.55	2880	③	-
	2/4	3~400	BOX-S 28-2/4D/0.55/0.1-60x30	0.55/0.1	2880/1440	③	④
315	2	1~230	BOX-S 31-2E/1.1-60x35	1.1	2880	⑤	-
	2	3~400	BOX-S 31-2D/1.1-60x35	1.1	2880	⑤	-
	2/4	3~400	BOX-S 31-2/4D/1.1/0.25-60x35	1.1/0.25	2880/1440	⑤	⑥
355	4	1~230	BOX-S 35-4E/0.37-70x40	0.37	1420	⑦	-
	4	3~400	BOX-S 35-4D/0.37-70x40	0.37	1420	⑦	-
	4/6	3~400	BOX-S 35-4/6D/0.55/0.1-70x40	0.55/0.1	1420/905	⑦	⑧

Standard size: 25

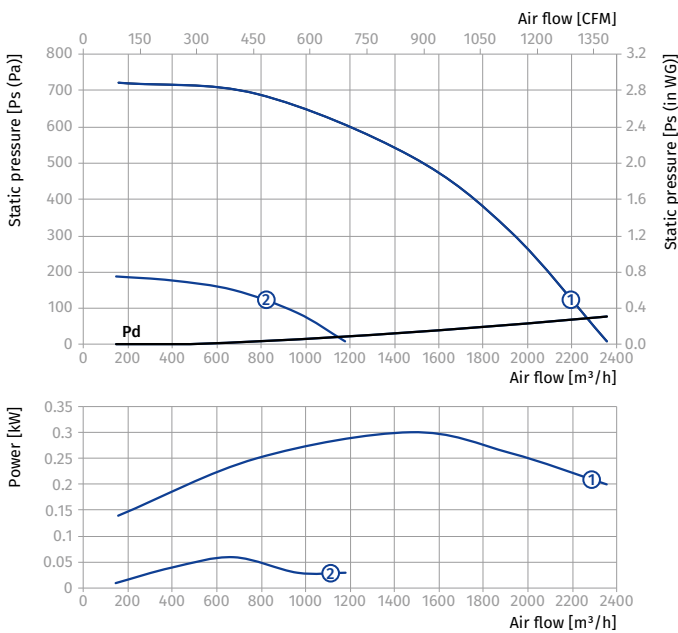

Standard size: 28

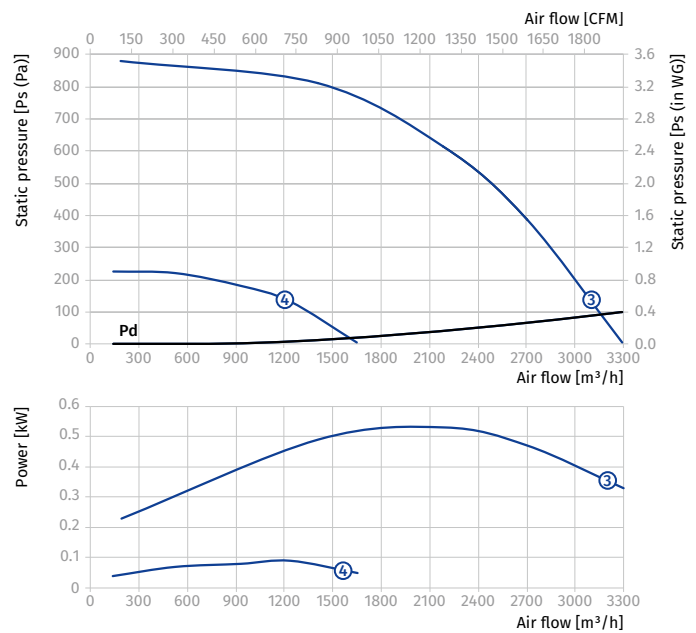

Standard size: 31

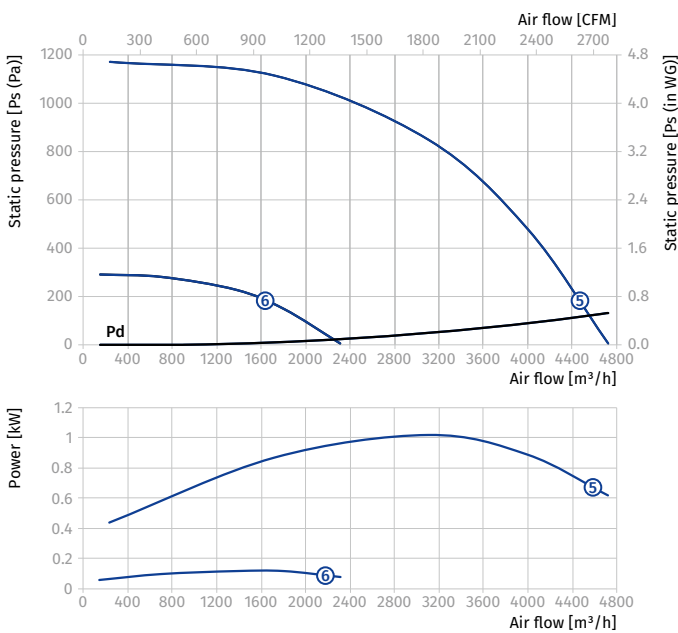

Standard size: 35

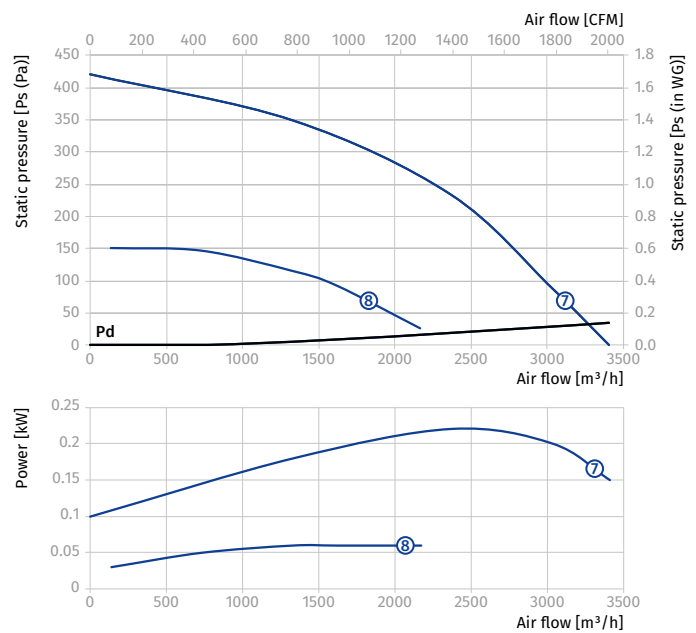

Standard size	Number of poles	Voltage [V/50 Hz]	Fan model	Rated power Ny [kW]	RPM [min ⁻¹]	High speed chart number	Low speed chart number
400	4	1~230	BOX-S 40-4E/0.55-70x50	0.55	1420	①	-
	4	3~400	BOX-S 40-4D/0.55-70x50	0.55	1420	①	-
	4/6	3~400	BOX-S 40-4/6D/0.55/0.25-70x50	0.55/0.25	1420/905	①	②
450	4	1~230	BOX-S 45-4E/0.75-80x60	0.75	1435	③	-
	4	3~400	BOX-S 45-4D/0.75-80x60	0.75	1435	③	-
	4/6	3~400	BOX-S 45-4/6D/0.8/0.2-80x60	0.8/0.2	1435/905	③	④
500	4	1~230	BOX-S 50-4E/1.5-80x60	1.5	1430	⑤	-
	4	3~400	BOX-S 50-4D/1.5-80x60	1.5	1430	⑤	-
	4/6	3~400	BOX-S 50-4/6D/1.5/0.37-80x60	1.5/0.37	1430/920	⑤	⑥
560	4	1~230	BOX-S 56-4E/3-90x70	3	1435	⑦	-
	4	3~400	BOX-S 56-4D/3-90x70	3	1435	⑦	-
	4/6	3~400	BOX-S 56-4/6D/2.8/0.7-90x70	2.8/0.7	1435/950	⑦	⑧
	4/8	3~400	BOX-S 56-4/8D/2.8/0.55-90x70	2.8/0.55	1435/710	⑦	⑨

Standard size: 40

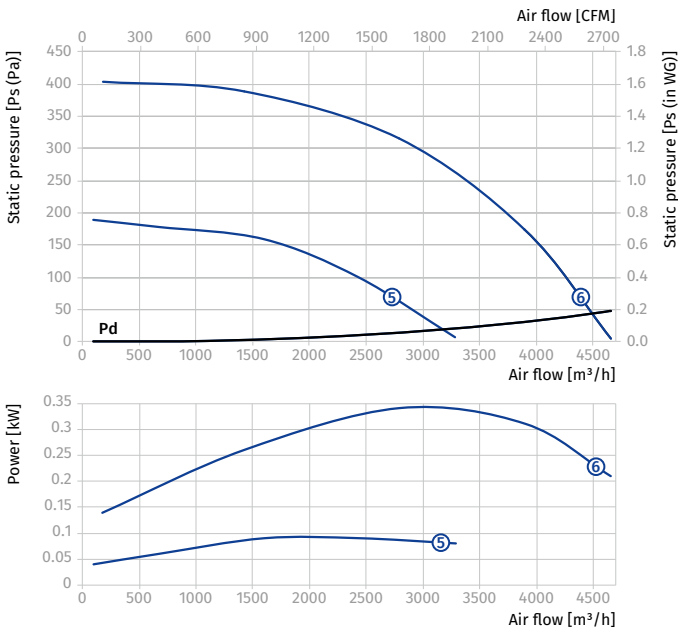

Standard size: 45

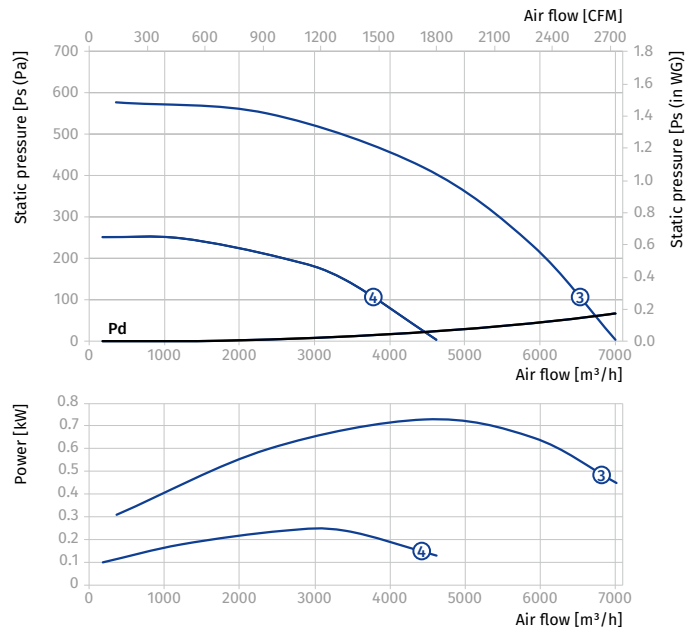

Standard size: 50

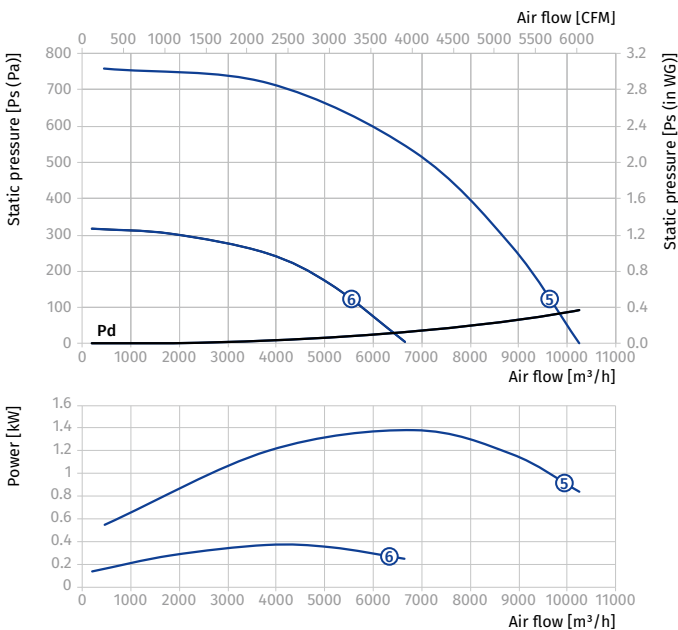

Standard size: 56

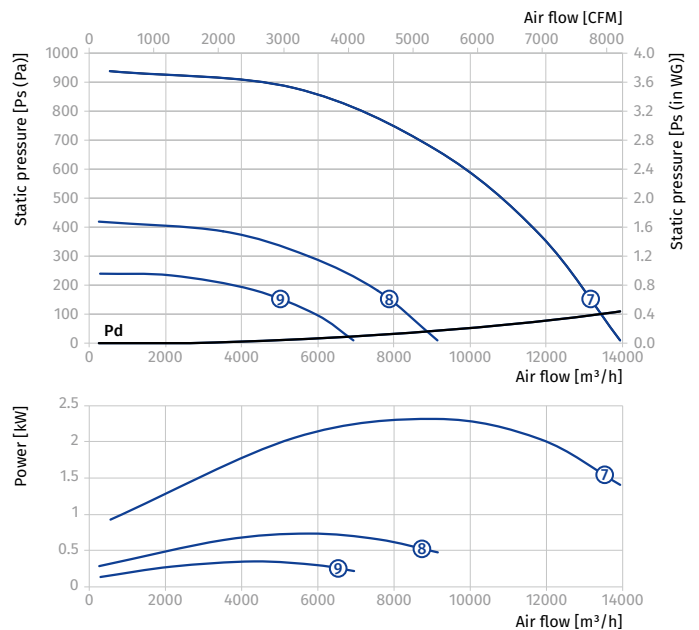

Standard size	Number of poles	Voltage [V/50 Hz]	Fan model	Rated power Ny [kW]	RPM [min ⁻¹]	High speed chart number	Low speed chart number
630	4	3~400	BOX-S 63-4D/4-100x80	4	1445	①	-
	4/6	3~400	BOX-S 63-4/6D/3.8/1-100x80	3.8/1	1445/950	①	②
	4/8	3~400	BOX-S 63-4/8D/3.8/0.75-100x80	3.8/0.75	1445/720	①	③
710	4	3~400	BOX-S 71-4D/7.5-120x90	7.5	1455	④	-
	4/6	3~400	BOX-S 71-4/6D/7.5/2.2-120x90	7.5/2.2	1455/960	④	⑤
	4/8	3~400	BOX-S 71-4/8D/7.5/1-120x90	7.5/1	1455/720	④	⑥

Standard size: 63

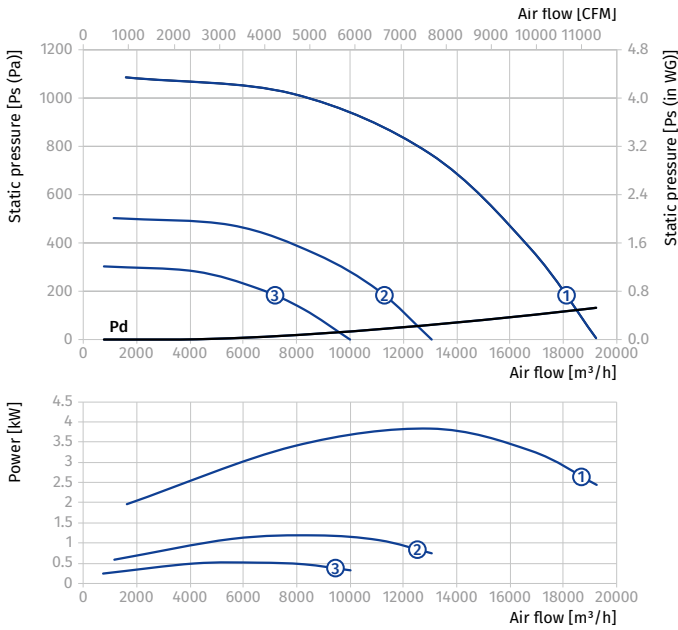

Standard size: 71

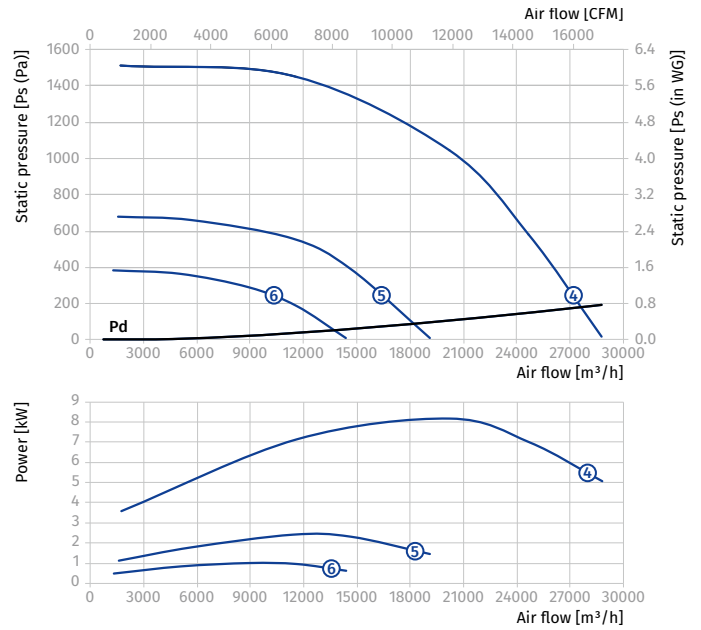

Standard size	Number of poles	Voltage [V/50 Hz]	Fan model	Rated power N_y [kW]	RPM [min ⁻¹]	Speed chart number
40	4	3~400	BOX-S 40-4D/1.1-70x50-60Hz	1,1	1749	①
45	4	3~400	BOX-S 45-4D/1.5-80x60-60Hz	1,5	1744	②
50	4	3~400	BOX-S 50-4D/2.2-80x60-60Hz	2,2	1748	③
56	4	3~400	BOX-S 56-4D/4.0-90x70-60Hz	4	1764	④

Standard size: 40

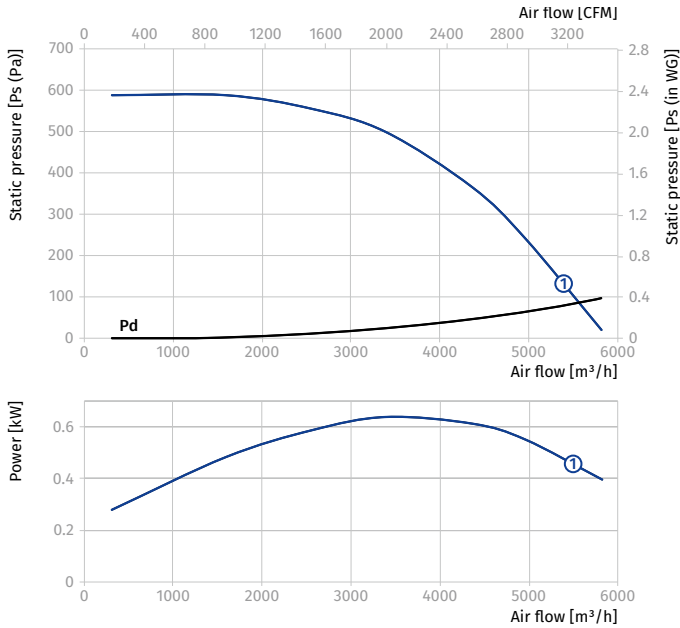

Standard size: 45

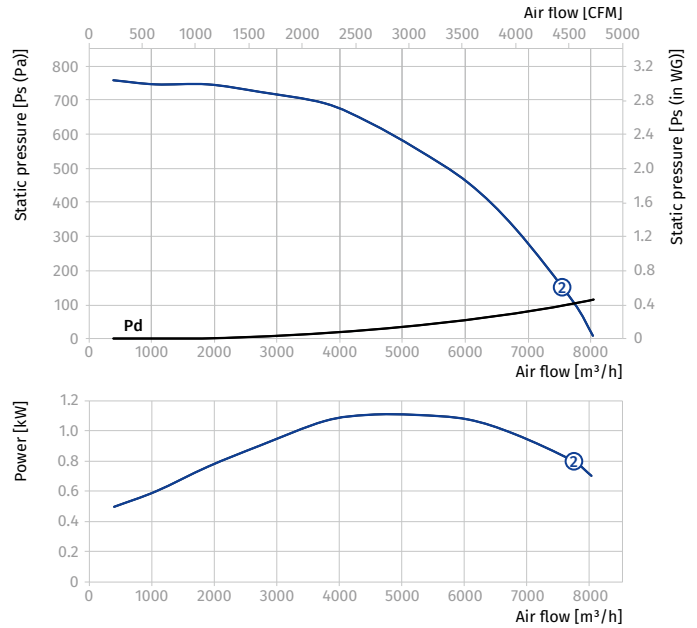

Standard size: 50

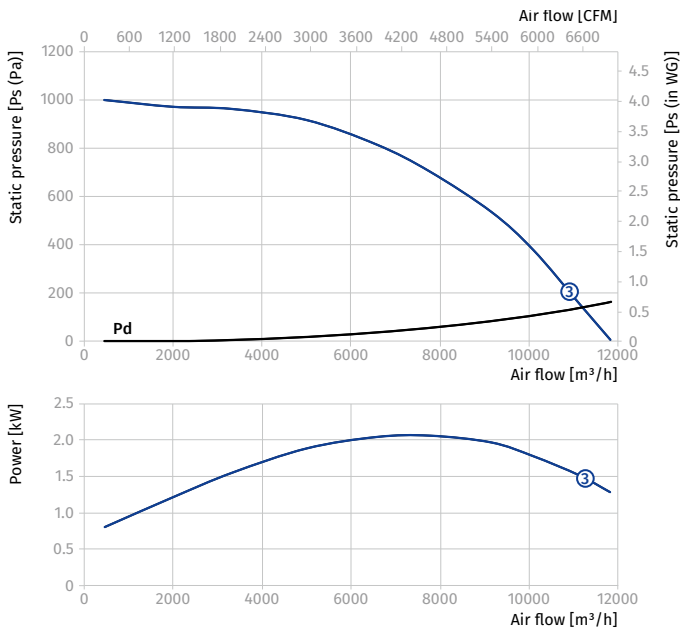

Standard size: 56

