



CENTRIFUGAL EXHAUST FAN



EN

Qubit

User's manual

CONTENTS

Brief description	8
Delivery set	8
Operation guidelines	8
Designation key.....	9
Mounting and set-up.....	11
Connection to power mains	14
Fan options.....	17
Technical maintenance	21
Troubleshooting.....	22
Storage and transportation regulations.....	23
Manufacturer's warranty	24

This user's manual is a main operating document intended for technical, maintenance, and operating staff. The manual contains information about purpose, technical details, operating principle, design, and installation of the Qubit unit and all its modifications.

Technical and maintenance staff must have theoretical and practical training in the field of ventilation systems and should be able to work in accordance with workplace safety rules as well as construction norms and standards applicable in the territory of the country.



**READ THE USER'S MANUAL CAREFULLY BEFORE PROCEEDING WITH INSTALLATION WORKS.
COMPLIANCE WITH THE MANUAL REQUIREMENTS ENSURES RELIABLE OPERATION AND LONG
SERVICE LIFE OF THE UNIT. KEEP THE USER'S MANUAL AVAILABLE AS LONG AS YOU USE THE UNIT.
YOU MAY NEED TO REREAD THE INFORMATION ON THE PRODUCT SERVICING.**

This unit is not intended for use by persons (including children) with reduced physical, sensory or mental capabilities, or lack of experience and knowledge, unless they have been given supervision or instruction concerning use of the unit by a person responsible for their safety.

Children should be supervised to ensure that they do not play with the unit.

This appliance can be used by children aged from 8 years and above and persons with reduced physical, sensory or mental capabilities or lack of experience and knowledge if they have been given supervision or instruction concerning use of the appliance in a safe way and understand the hazards involved.

Cleaning and user maintenance shall not be made by children without supervision.

Children shall not play with the appliance.

Precautions must be taken to avoid the back-flow of gases into the room from the open flue of gas or other fuel-burning appliances.

The appliance may adversely affect the safe operation of appliances burning gas or other fuels (including those in other rooms) due to back flow of combustion gases. These gases can potentially result in carbon monoxide poisoning. After installation of the unit the operation of flued gas appliances should be tested by a competent person to ensure that back flow of combustion gases does not occur. Connection to the mains must be made through a disconnecting device, which is integrated into the fixed wiring system in accordance with the wiring rules for design of electrical units, and has a contact separation in all poles that allows for full disconnection under overvoltage category III conditions.

Ensure that the unit is switched off from the supply mains before removing the guard.

Do not attach the product to the support using glue or adhesives. Use only the fastening method specified in the «User's manual».

All operations described in this manual must be performed by qualified personnel only, properly trained and qualified to install, make electrical connections and maintain ventilation units.

Do not attempt to install the product, connect it to the mains, or perform maintenance yourself.

This is unsafe and impossible without special knowledge.

Disconnect the power supply prior to any operations with the unit.

All user's manual requirements as well as the provisions of all the applicable local and national construction, electrical, and technical norms and standards must be observed when installing and operating the unit.

Disconnect the unit from the power supply prior to any connection, servicing, maintenance, and repair operations.

Connection of the unit to power mains is allowed by a qualified electrician with a work permit for the electric units up to 1000 V after careful reading of the present user's manual.

Check the unit for any visible damage of the impeller, the casing, and the grille before starting installation. The casing internals must be free

of any foreign objects that can damage the impeller blades.

While mounting the unit, avoid compression of the casing!

Deformation of the casing may result in motor jam and excessive noise.

Misuse of the unit and any unauthorised modifications are not allowed.

Do not expose the unit to adverse atmospheric agents (rain, sun, etc.).

Transported air must not contain any dust or other solid impurities, sticky substances, or fibrous materials.

Do not use the unit in a hazardous or explosive environment containing spirits, gasoline, insecticides, etc.

Do not close or block the intake or extract vents in order to ensure the efficient air flow.

Do not sit on the unit and do not put objects on it.

The information in this user's manual was correct at the time of the document's preparation.

The Company reserves the right to modify the technical characteristics, design, or configuration of its products at any time in order to incorporate the latest technological developments.

Never touch the unit with wet or damp hands.

Never touch the unit when barefoot.

BEFORE INSTALLING ADDITIONAL EXTERNAL DEVICES, READ THE RELEVANT USER MANUALS.



**THE PRODUCT MUST BE DISPOSED SEPARATELY AT THE END OF ITS SERVICE LIFE.
DO NOT DISPOSE THE UNIT AS UNSORTED DOMESTIC WASTE.**

BRIEF DESCRIPTION

The product is a two-speed pressure fan for exhaust ventilation of small and medium sized domestic premises.

The fan is designed for wall or ceiling mounting with direct air exhaust to the ventilation shaft or into the round air duct of matching diameter.

DELIVERY SET

Fan assembly, pc.	1
Set of mounting elements, pc.	1
User's manual, pc.	1
Packing box, pc.	1

OPERATION GUIDELINES

The fan is rated for connection to single-phase AC 220...240 V / 50 Hz power mains.

Ingress protection rating against access to hazardous parts and water ingress is IP45.

The fan is rated for operation at the ambient temperature ranging from +1 °C up to +40 °C.

The unit is rated as a Class II electrical appliance.

DESIGNATION KEY

Qubit - E H

Additional options

_ – without options, standard

T – turn-on/off delay timer and interval timer

H – humidity sensor + turn-on/off delay timer and interval timer

IR – motion sensor + turn-on/off delay timer and interval timer

Casing type

E – casing for surface mounting

Series

Qubit

The sensors built into the product are not a metrologically accurate means of measurement.

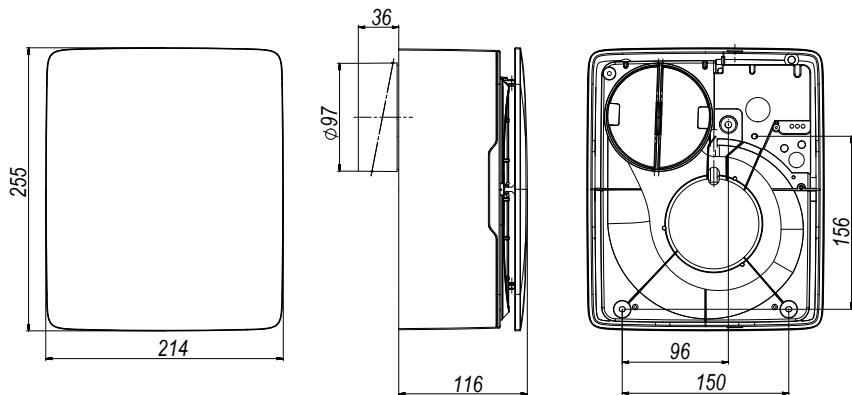
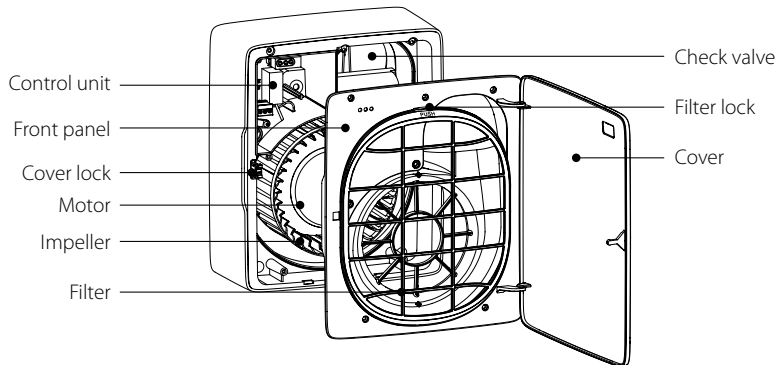

MOUNTING AND SET-UP

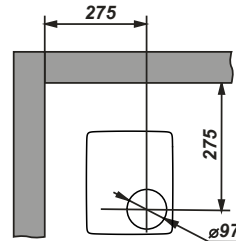
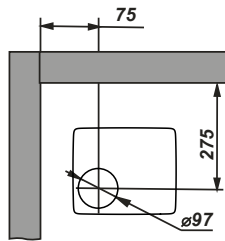
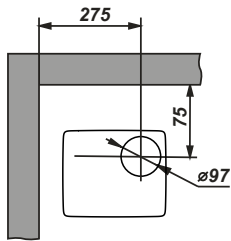
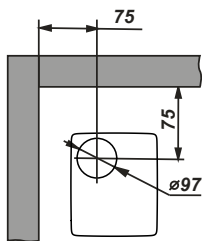
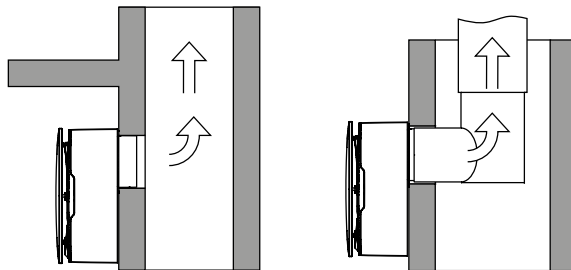

The fan is designed for vertical or horizontal ceiling mounting with direct air exhaust to the ventilation shaft or into the round air duct of matching diameter.

The fan mounting sequence:

- Open the cover by pressing the lock;
- Remove the filter by pressing on the upper part;
- Unscrew the screws and remove the front panel;
- Prepare the holes for mounting, install the dowels;
- Route the power cable into the fan casing;
- Secure the fan.

Lock for filter removal

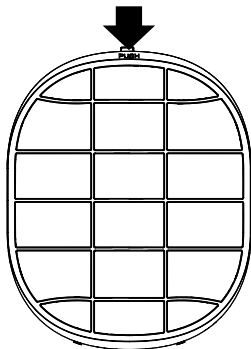

Front panel mounting

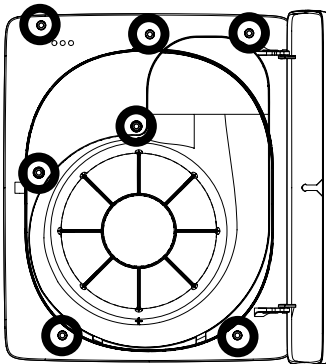

Mounting and cable entry points

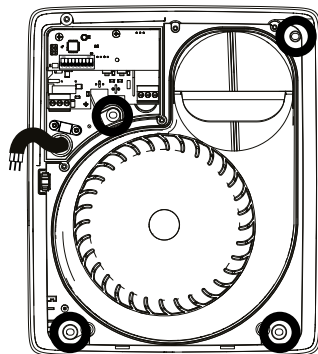

Location of the check valve

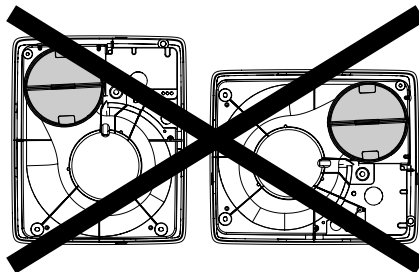
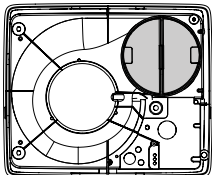
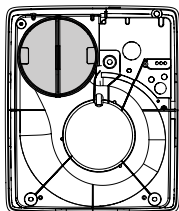

Before installing the fan, check the position of the check valve, which should close when there is no air flow.

The check valve is normally installed in a vertical position.

If during installation the valve is oriented horizontally, remove the spigot with the valve, turn it 90° and reinstall the spigot.

The axis of the check valve must be oriented vertically.

CONNECTION TO POWER MAINS

For fans without options

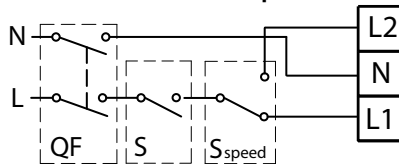

N – neutral; L – phase; L1 - low speed; L2 - high speed;
 QF– automatic circuit breaker; S — external switch; S speed - speed switch.

For fans with options

Terminal block for power supply connection

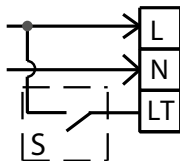

Terminal block for connecting a dry contact relay

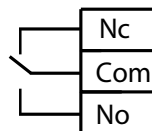

L – phase; N – neutral; LT - high speed; S – speed switch;
 Nc – normally closed contact; Com – common contact; No – normally open contact.

Dry contact relay

Used to send a signal to other devices that the fan has switched to high speed.

The dry contact relay has two positions:

- Normally open. When the fan is running at low speed, contacts Com and Nc are short-circuited, while contacts Com and No are open;
- Normally closed. When the fan is running at high speed, the contacts Com and No are short-circuited, while contacts Com and Nc are open.

Follow these steps to connect the fan to the power supply:

- Disconnect the fan power supply;
- Route the cables through the casing opening;
- Strip the insulation from the ends of the cables to a length of 7-8 mm;
- Connect the electrical connections according to the relevant diagram and the markings on the terminal block;
- Secure the cables with a bar;
- Assemble the fan: install the front panel, filter, etc.;
- Supply power to the fan.

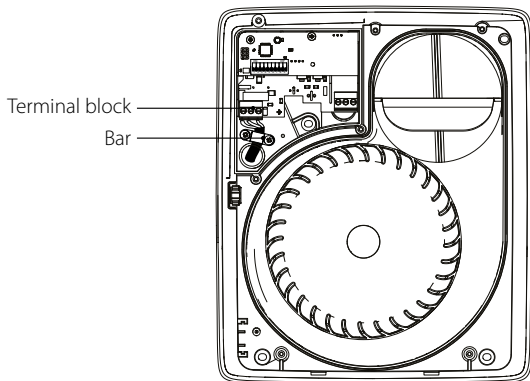

ATTENTION!

The power supply cables must only be routed to the location in the casing specified by the manufacturer. Routing the power supply cables through an unauthorised opening will invalidate the manufacturer's liability for the product and void the warranty.

FAN OPTIONS

The fans are configured using the DIP switches on the product control board.

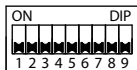

T – with a timer

After activating a switch, such as a light switch, the fan switches to high speed after a time interval set by the turn-on delay timer. After the switch is turned off, the fan continues to run at high speed for the time set by the turn-off delay timer. Low speed selection and interval timer are available.

Turn-on delay timer				Interval timer	
0 min	1 min	2 min	5 min	OFF	ON
Turn-off delay timer				Low speed	
0 min	5 min	15 min	30 min	OFF	ON

Interval timer

When the interval timer mode is activated, the fan runs at high speed for 30 minutes every 4 hours.

When this occurs, the activated sensors remain active.

If the low speed was set to a value other than 0 m³/h before the interval timer mode was activated, the fan stops running when the interval timer is activated and starts counting down 4 hours until it starts running again at high speed for 30 minutes.

When the humidity sensor is triggered, the fan starts to run at high speed, and after the sensor signal disappears, it continues to run for the time set by the turn-off delay timer, then stops running and starts counting down 4 hours until the next time it starts to run again.

If the motion sensor is triggered or the external switch is activated (LT terminal), the fan starts to run at high speed after the countdown of the turn-on delay timer, and when the sensor signal disappears or the external switch is turned off, it continues to run for the time set by the turn-off delay timer, then stops running, and starts counting down 4 hours until the next time it starts to run again.

If the sensor is triggered or the external switch activation coincides with a 30 minute period of fan high speed operation, the fan will run at high speed until the sensor signal disappears or the external switch is turned off and for the duration set by the turn-off delay timer.



The fan will then stop running and start counting down 4 hours until it starts to run again.







H – with timer and humidity sensor







The fan switches to high speed when the set humidity level in the room is exceeded.

The fan continues to run at high speed for the time set by the turn-off delay timer.

Low speed selection, interval timer, and activation or deactivation of intelligent humidity control are available.

Interval timer			
OFF	ON		
 5	 5		

Turn-off delay timer				Low speed	
0 min	5 min	15 min	30 min	OFF	ON
 3 4	 3 4	 3 4	 3 4	 6	 6

Humidity sensor activation threshold				Intelligent humidity sensor	
60 %	70 %	80 %	90 %	OFF	ON
 8 9	 8 9	 8 9	 8 9	 7	 7

Humidity sensor accuracy is $\pm 5\%$.

Intelligent humidity control.

This mode allows for the automatic change of the humidity threshold value.

The fan independently selects the optimal humidity threshold for the room in which it is installed.

The humidity threshold is selected by analysing statistical data on the humidity level in the room.

IR – with timer and motion sensor

The fan switches to high speed when the motion sensor is triggered after a time interval set by the turn-on delay timer. After motion is no longer detected, the fan continues to run at high speed for the time set by the turn-off delay timer. Low speed selection, interval timer and motion sensor activation/deactivation are available.

Turn-on delay timer				Interval timer		Low speed	
0 min	1 min	2 min	5 min	OFF	ON	OFF	ON
1 2	1 2	1 2	1 2	5	5	6	6

Turn-off delay timer				Motion sensor	
0 min	5 min	15 min	30 min	OFF	ON
3 4	3 4	3 4	3 4	7	7



**THE CONTROL BOARD IS LIVE.
MAKE SURE THE FAN IS DISCONNECTED FROM POWER SUPPLY.**

TECHNICAL MAINTENANCE

Technical maintenance consists of periodic cleaning of the filter when it is dirty and cleaning of the product surfaces from dust and dirt every 6 months.

Follow these steps to clean the filter and fan from dust and dirt:

- Disconnect the unit from power supply.
- Open the cover;
- Remove the filter;
- Clean the filter and front panel.

The impeller blades require thorough cleaning once in 12 months.

Maintenance steps are as follows:

- Unscrew the screws and remove the front panel;
- Clean the fan surfaces and the impeller.

After maintenance, reassemble the fan in the reverse order and connect it to the power supply.

ATTENTION! Do not allow water or liquid come into contact with electric components!

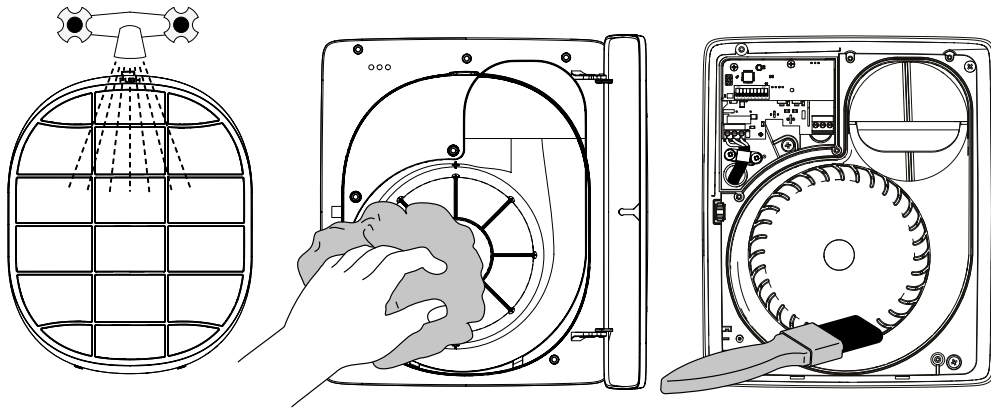

TROUBLESHOOTING

Problem	Possible reasons	Troubleshooting
When the unit is connected to power mains, the fan does not rotate and does not respond to any controls.	No power supply.	Make sure the power supply line is connected correctly, otherwise troubleshoot a connection error.
	Internal connection fault.	Contact the Seller.
Low air flow.	The ventilation system is clogged.	Clean the ventilation system.
Increased noise, vibration.	The impeller is clogged.	Clean the impeller.
	The fan is not secured well or is not mounted properly.	Troubleshoot the installation error.
	The ventilation system is clogged.	Clean the ventilation system.

STORAGE AND TRANSPORTATION REGULATIONS

- Store the unit in the manufacturer's original packaging box in a dry closed ventilated premise with temperature range from +5 °C up to +40 °C and relative humidity up to 70 %.
- Storage environment must not contain aggressive vapors and chemical mixtures provoking corrosion, insulation, and sealing deformation.
- Use suitable hoist machinery for handling and storage operations to prevent possible damage to the unit.
- Follow the handling requirements applicable for the particular type of cargo.
- The unit can be carried in the original packaging by any mode of transport provided proper protection against precipitation and mechanical damage. The unit must be transported only in the working position.
- Avoid sharp blows, scratches, or rough handling during loading and unloading.
- Prior to the initial power-up after transportation at low temperatures, allow the unit to warm up at operating temperature for at least 3-4 hours.

MANUFACTURER'S WARRANTY

The product is in compliance with EU norms and standards on low voltage guidelines and electromagnetic compatibility. We hereby declare that the product complies with the provisions of Electromagnetic Compatibility (EMC) Directive 2014/30/EU of the European Parliament and of the Council, Low Voltage Directive (LVD) 2014/35/EU of the European Parliament and of the Council and CE-marking Council Directive 93/68/EEC. This certificate is issued following test carried out on samples of the product referred to above.

The manufacturer hereby warrants normal operation of the unit for 60 months after the retail sale date provided the user's observance of the transportation, storage, installation, and operation regulations. Should any malfunctions occur in the course of the unit operation through the Manufacturer's fault during the guaranteed period of operation, the user is entitled to get all the faults eliminated by the manufacturer by means of warranty repair at the factory free of charge. The warranty repair includes work specific to elimination of faults in the unit operation to ensure its intended use by the user within the guaranteed period of operation. The faults are eliminated by means of replacement or repair of the unit components or a specific part of such unit component.

The warranty repair does not include:

- routine technical maintenance
- unit installation/dismantling
- unit setup

To benefit from warranty repair, the user must provide the unit, the user's manual with the purchase date stamp, and the payment paperwork certifying the purchase. The unit model must comply with the one stated in the user's manual. Contact the Seller for warranty service.

The manufacturer's warranty does not apply to the following cases:

- User's failure to submit the unit with the entire delivery package as stated in the user's manual including submission with missing component parts previously dismantled by the user.
- Mismatch of the unit model and the brand name with the information stated on the unit packaging and in the user's manual.
- User's failure to ensure timely technical maintenance of the unit.
- External damage to the unit casing (excluding external modifications as required for installation) and internal components caused by the user.
- Redesign or engineering changes to the unit.

- Replacement and use of any assemblies, parts and components not approved by the manufacturer.
- Unit misuse.
- Violation of the unit installation regulations by the user.
- Violation of the unit control regulations by the user.
- Unit connection to power mains with a voltage different from the one stated in the user's manual.
- Unit breakdown due to voltage surges in power mains.
- Discretionary repair of the unit by the user.
- Unit repair by any persons without the manufacturer's authorization.
- Expiration of the unit warranty period.
- Violation of the unit transportation regulations by the user.
- Violation of the unit storage regulations by the user.
- Wrongful actions against the unit committed by third parties.
- Unit breakdown due to circumstances of insuperable force (fire, flood, earthquake, war, hostilities of any kind, blockades).
- Missing seals if provided by the user's manual.
- Failure to submit the user's manual with the unit purchase date stamp.
- Missing payment paperwork certifying the unit purchase.



FOLLOWING THE REGULATIONS STIPULATED HEREIN WILL ENSURE A LONG AND TROUBLE-FREE OPERATION OF THE UNIT



USER'S WARRANTY CLAIMS SHALL BE SUBJECT TO REVIEW ONLY UPON PRESENTATION OF THE UNIT, THE PAYMENT DOCUMENT AND THE USER'S MANUAL WITH THE PURCHASE DATE STAMP

Quality Inspector's Stamp

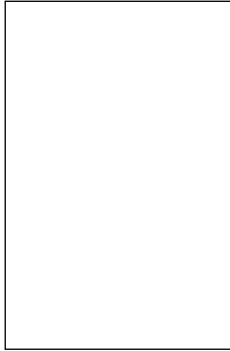
A large, empty rectangular box with a thin black border, intended for a quality inspector's stamp.

Sold by
(name and stamp of the seller)

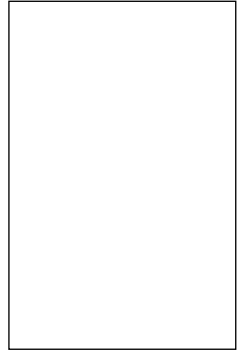
A large, empty rectangular box with a thin black border, intended for the seller's name and stamp.

Manufacture Date

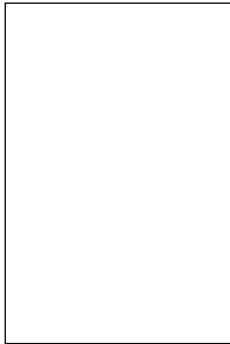
A large, empty rectangular box with a thin black border, intended for the manufacture date.

Purchase Date

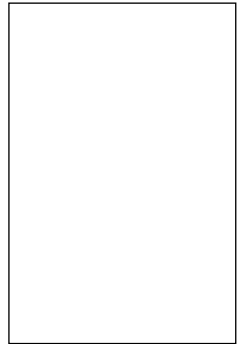
A large, empty rectangular box with a thin black border, intended for the purchase date.

Qubit _____

